



Integrated Transceiver Module for ZigBee/IEEE 802.15.4 Evaluation Kit available; part number ZFSM-101-KIT-1

DESCRIPTION

The FreeStar is a miniature, fully-integrated, drop-in RF transmission solution that's ideal for ZigBee and other low cost, low power IEEE 802.15.4 RF transmission applications. FreeStar incorporates the MC13192 transceiver IC and MC9S08GT60 microprocessor from Freescale™ with the NEC UPG2301TQ Power Amplifier and Inverted-F PCB antenna. It delivers up to 4000 feet of range and features a streamlined communications protocol that results in the lowest power consumption in transmit mode of any module on the market. The FreeStar is also FCC and CE certified, which eliminates the need for a costly and time-consuming approval process when incorporated into your design.

FEATURES

- **Communication Modes:** Point-to-Point, Point-to-Multipoint, Mesh Networking
- **4000+ feet line of sight performance**
- **Very small form factor:** 1.4" x 1.0"
- **Integrated PCB Trace Antenna**
- **FCC, IC, and CE Certified**
- **RoHS Compliance**
- **Direct Sequence Spread Spectrum**
- **CSMA-CA**
- **Wireless boot loader***
- **Flash-based/upgradable**
- **10 Bit A/D (2 inputs)**
- **General Purpose I/O (8 ports)**
- **Microsoft® Windows®-based Configuration and Test Tool**
- **Simple Serial UART Interface**
- **Over 65,000 network addresses**



Caution Observe precautions when handling because these devices are sensitive to electrostatic discharge

The information in this document is subject to change without notice. Before using this document, please confirm that this is the latest version.

ORDERING INFORMATION

Part Number	Order Number	Description	Mins/Mults	Status
FreeStar	ZFSM-101-1	Freestar 100mW transceiver module PCB Trace Antenna	N/A	Discontinued
ZFSM-101-1	ZFSM-101-KIT-1	100mW Freestar Module Kit	1	Not Recommended For New Design

DISCONTINUED

EMC CERTIFICATIONS

FCC Part 15.247 Module Certified (Portable)
 EN 300 328 1 Certified / CE Approved

MOISTURE SENSITIVITY LEVEL (MSL)

MSL 3, per J-STD-033

ABSOLUTE MAXIMUM RATINGS

Rating	Value	Unit
Power Supply Voltage	3.6	Vdc
RF Input Power	+10	dBm
Storage Temperature Range	-55 to 125	°C

RECOMMENDED OPERATING CONDITIONS

Characteristic	Min	Typ	Max	Unit
Power Supply Voltage (Vdd)	2.4	3.3	3.6	Vdc
Input Frequency	2405		2480	MHz
Ambient Temperature Range	-40	25	85	°C
Logic Input Low Voltage	0		30% Vdd	V
Logic Input High Voltage	70% Vdd		Vdd	V

DISCONTINUED

ELECTRICAL SPECIFICATIONS ($V_{dd} = 3.3\text{ V}$, Temperature = 25°C unless otherwise noted)

Parameter	Min	Typ	Max	Unit
General Characteristics				
RF Frequency Range	2400		2483.5	MHz
Output power (Software controlled)	10		100	mW
Receiver Sensitivity @ 1% PER		-92		dBm
RF Data Rate		250		kbps
Host Data Rate		19.2		
Voltage Operating Range	2.4		3.6	V
General Purpose Digital I/O (8 Pins)				
RF Channels (channel 16 is set at a reduced power level)				
DC Electrical Characteristics				
Power Supply Current (V_{dd})				
Transmit Mode				
	10mW		125	mA
	100mW		150	mA
Receive Mode		42	45	dBm
Standby Mode			< 5	dBm
Output High Voltage (All digital outputs)	80% V_{dd}		V_{dd}	dBm
Output Low Voltage (All digital outputs)	0		20% V_{dd}	dBm
AC Electrical Characteristics				
Sensitivity for 1% packet error rate (-40 to +85°C)	2.5	-92		dBm
Sensitivity for 1% packet error rate (25°C)	31.25	-92	-87	dBm
Saturation (maximum input level)		10		dBm
Nominal Output Power		20		dBm
Output Power Control Range (+20 to -10 dBm)		30		dB
Error Vector Magnitude (EVM)			35	%
Over the Air Data Rate		250		kbps
On-board antenna gain (peak)		0.8		dBi
On-board antenna gain (average)		-3.1		dBi

PIN DEFINITIONS

PIN	TYPE	SIGNAL NAME	ELECTRICAL DESCRIPTION
ANT2	AO/AI	ANT2	INTEGRATED PBC F-ANTENNA
TPRF1	AO/AI	TPRF1	COAXIAL RF TEST POINT – 50 OHMS
1	GND	GND	GROUND
2	GND	GND	GROUND
3	GND	GND	GROUND
4	GND	GND	GROUND
5	DI/DO	PTD3	GENERAL PURPOSE DIGITAL I/O FIRMWARE CONFIGURABLE, PORT D , BIT 3
6	DI/DO	PTD4	GENERAL PURPOSE DIGITAL I/O FIRMWARE CONFIGURABLE, PORT D , BIT 4
7	AI	PTB0	ANALOG TO DIGITAL CONVERTER INPUT, PORT B , INPUT 0
8	AI	PTB1	ANALOG TO DIGITAL CONVERTER INPUT, PORT B , INPUT 1
9	PI	VCC	PRIMARY POWER INPUT: VCC = 2.4 TO 3.6 VDC
10	GND	GND	GROUND
11	DI	MODE0	FCC / PRODUCTION TEST MODE INPUT WORD, BIT 0
12	DI	MODE1	FCC / PRODUCTION TEST MODE INPUT WORD, BIT 1
13	DI	MODE2	FCC / PRODUCTION TEST MODE INPUT WORD, BIT 2
14	DI/DO	PTA4	GENERAL PURPOSE DIGITAL I/O FIRMWARE CONFIGURABLE PORT A, BIT 4, KBI1P4 (KEYBOARD INTERRUPT)
15	DI/DO	PTA5	GENERAL PURPOSE DIGITAL I/O FIRMWARE CONFIGURABLE PORT A, BIT 5, KBI1P5 (KEYBOARD INTERRUPT)
16	DI/DO	PTA6	GENERAL PURPOSE DIGITAL I/O FIRMWARE CONFIGURABLE PORT A, BIT 6, KBI1P6 (KEYBOARD INTERRUPT)
17	DI	PTA7	DIGITAL INPUT CONFIGURED TO INTERRUPT ON RISING EDGE OF SIGNAL TO WAKE UP MODULE FROM SLEEP MODE. PORT A, BIT 7, KBI1P7 (KEYBOARD INTERRUPT)
18	DI/DO	PTGO	PORT G, BIT 0, BKGD/MS (BACKGROUND/MODE SELECT, FOR PROGRAMMING AND FIRMWARE DEBUG
19	DI/DO	/RESET ¹	MASTER RESET, ACTIVE LOW
20	DI/DO	PTC0	GENERAL PURPOSE DIGITAL I/O FIRMWARE CONFIGURABLE PORT C, BIT 0, SCI2 TXD2 (SERIAL COMMUNICATION INTERFACE 2, TRANSMIT DATA)
21	DI/DO	PTC1	GENERAL PURPOSE DIGITAL I/O FIRMWARE CONFIGURABLE PORT C, BIT 1, SCI2 RXD2 (SERIAL COMMUNICATION INTERFACE 2, RECEIVE DATA)
22	DI/DO	PTC5	RESERVED
23	DO	TXD	APPLICATION TRANSMIT DATA OUTPUT (SCI1, TXD1)
24	DI	RXD	APPLICATION RECEIVE DATA INPUT (SCI1, RXD1)
25	GND	GND	GROUND
26	GND	GND	GROUND
27	GND	GND	GROUND
28	GND	GND	GROUND
29	GND	GND	GROUND
30	GND	GND	GROUND

Note ¹ Use an Open Collector Output to Drive the Reset pin or put a 1k Ohm resistor in series with the driving source. Normally the reset pin is an output; however under brown out and other reset conditions the Freescale microcontroller will drive the pin low.

CONNECTOR LEGEND

TYPE	DEFINITION
DI	DIGITAL INPUT
DO	DIGITAL OUTPUT
AI	ANALOG INPUT
AO	ANALOG OUTPUT
PI	POWER INPUT
GND	GROUND
LOGIC INPUT HIGH	$0.8 (V_{CC}) < V_{IH} < (V_{CC})$
LOGIC INPUT LOW	$0 < V_{IL} < 0.2 (V_{CC})$
LOGIC OUTPUT HIGH	$(V_{CC} - 0.4) < V_{OH} < V_{CC}$
LOGIC OUTPUT LOW	$0 < V_{OL} < 0.4$

CONNECTOR CONFIGURATION

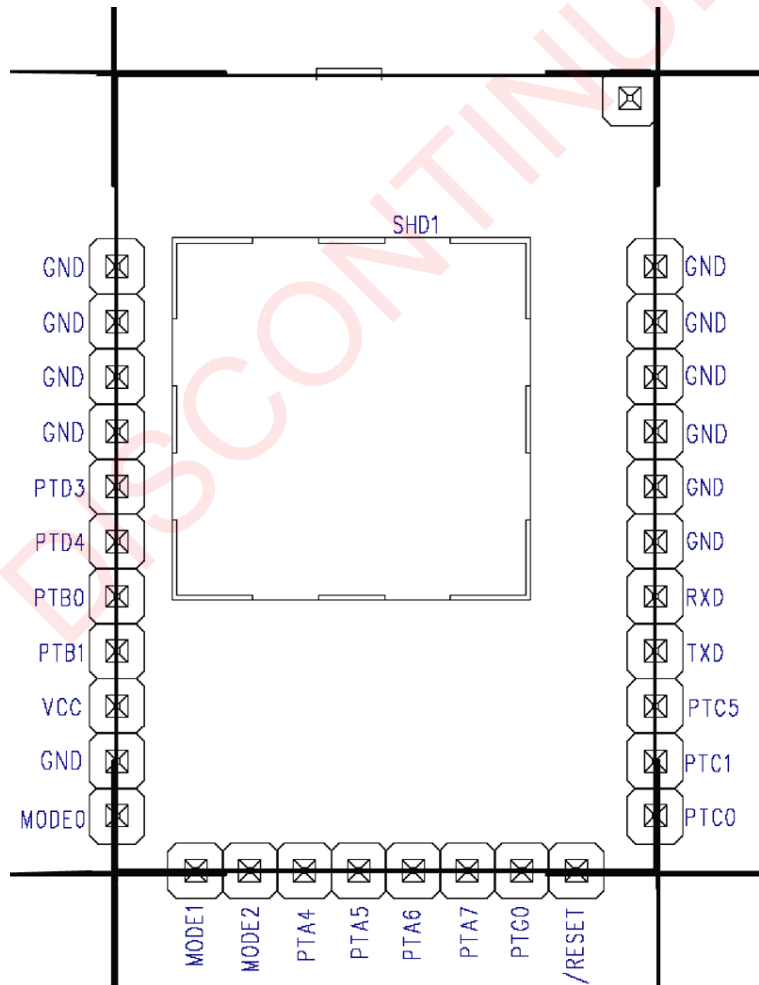

Note That PIN Numbering begins at top left-hand side with pin number 1 and follows counter-clockwise about the perimeter of the module.

RADIATION PATTERNS

FreeStar Rev B 2440 MHz			
Device Orientation	Polarization	Gain (dB)	
		Max	Avg
(V)	vertical	0.60	-1.72
(V)	horizontal	-7.27	-12.37
(H)	vertical	-4.00	-10.91
(H)	horizontal	0.02	-5.90
(F)	vertical	-6.62	-13.52
(F)	horizontal	0.85	-4.67
Total Avg. Gain (dB)		-3.15	

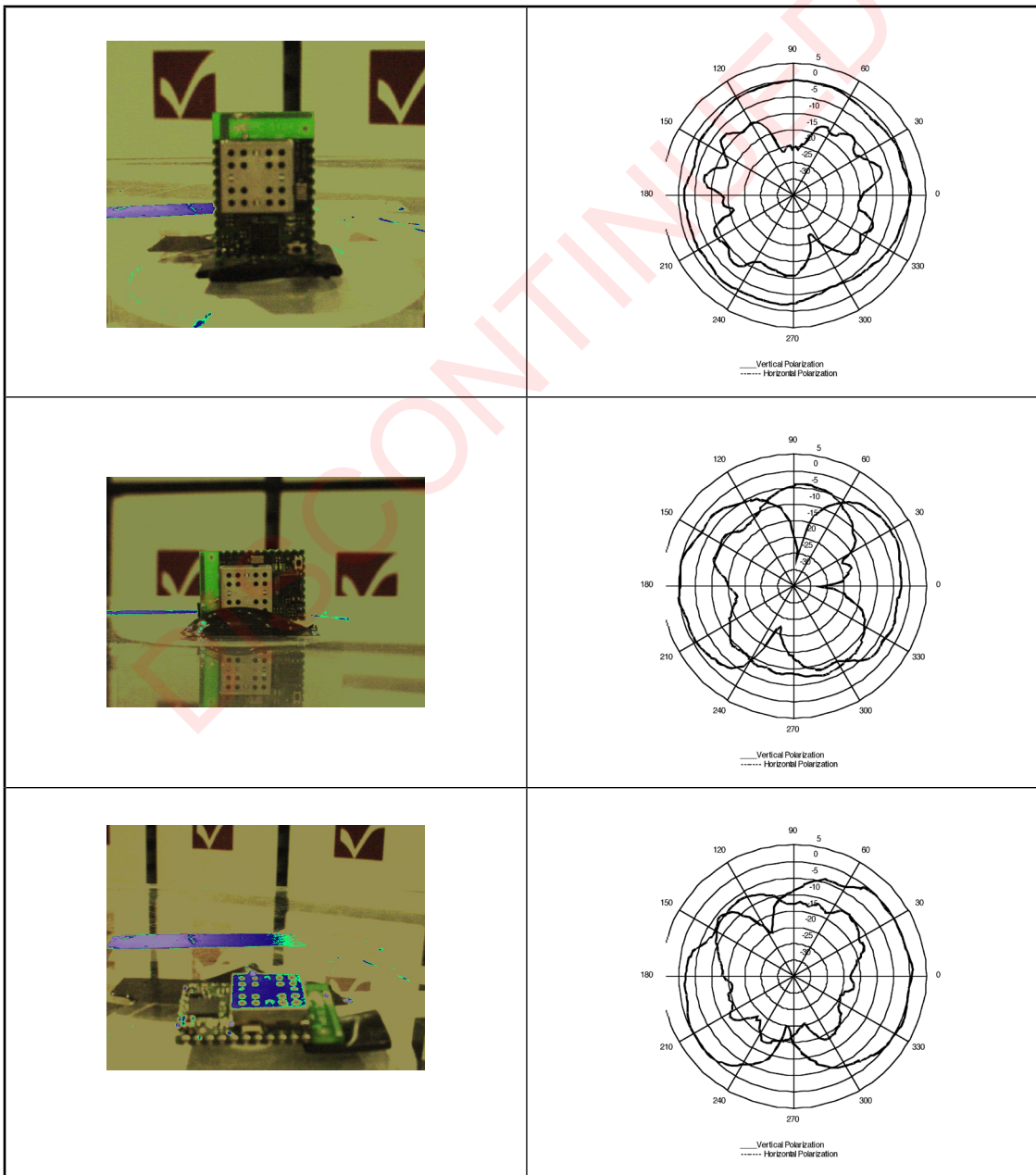

TYPICAL PERFORMANCE / CURVES

Typical Output power versus MC13192 power setting (Vdd 3.3V, 25°C)

Typical TX Power and TX Current vs Supply Voltage over Temperature

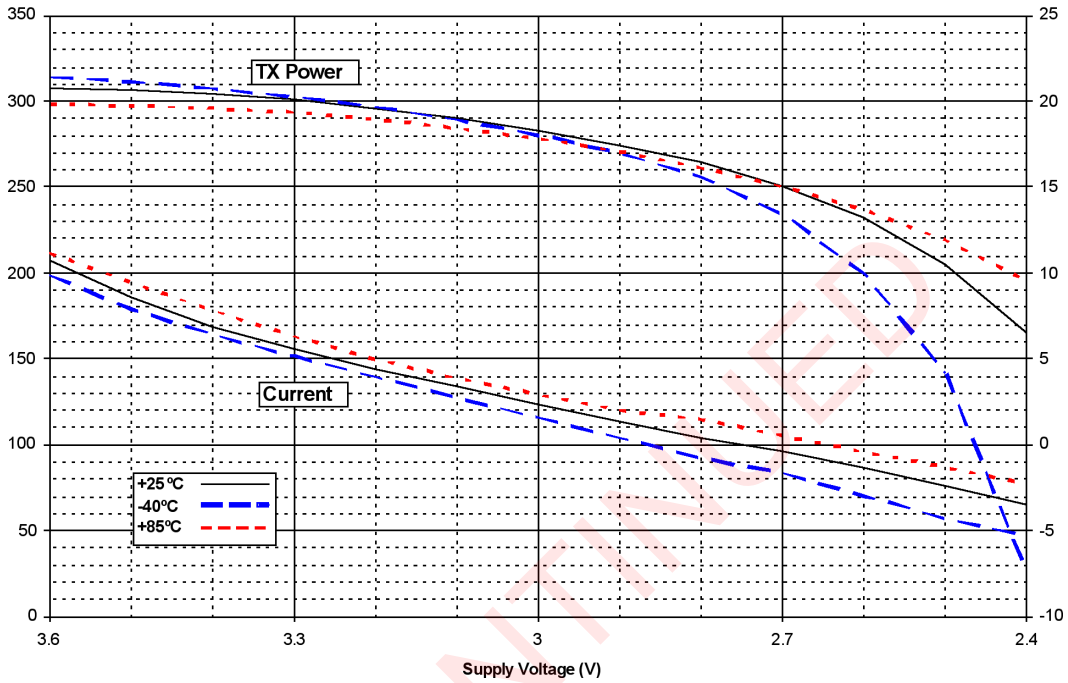

Power Setting	Output Power
> = 30	20 dBm
28	19.6 dBm
26	18.3 dBm
24	18 dBm
22	17.6 dBm
20	17 dBm
18	11.4 dBm
16	10.8 dBm
14	10.1 dBm
12	9.5 dBm
10	1.9 dBm
8	1.4 dBm
6	0.9 dBm
4	0.3 dBm
2	-9.7 dBm

Typical Output Spectrum of Transmitter

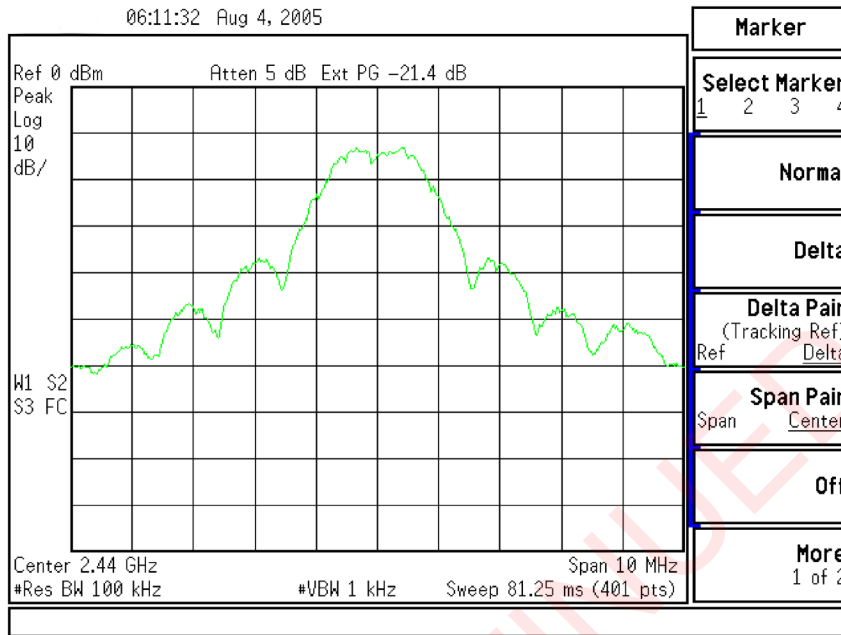

Receive Port Input Impedance at Antenna

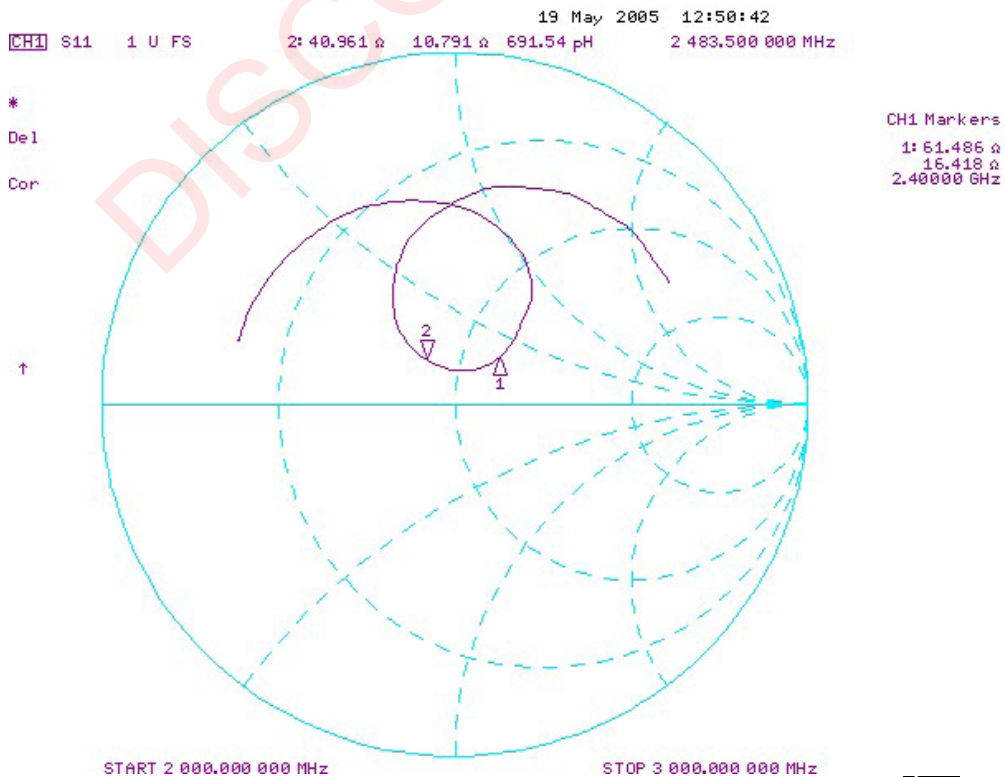

EXAMPLE INTERFACE DIAGRAMS

Sample Connection Diagram when Using Serial Interface

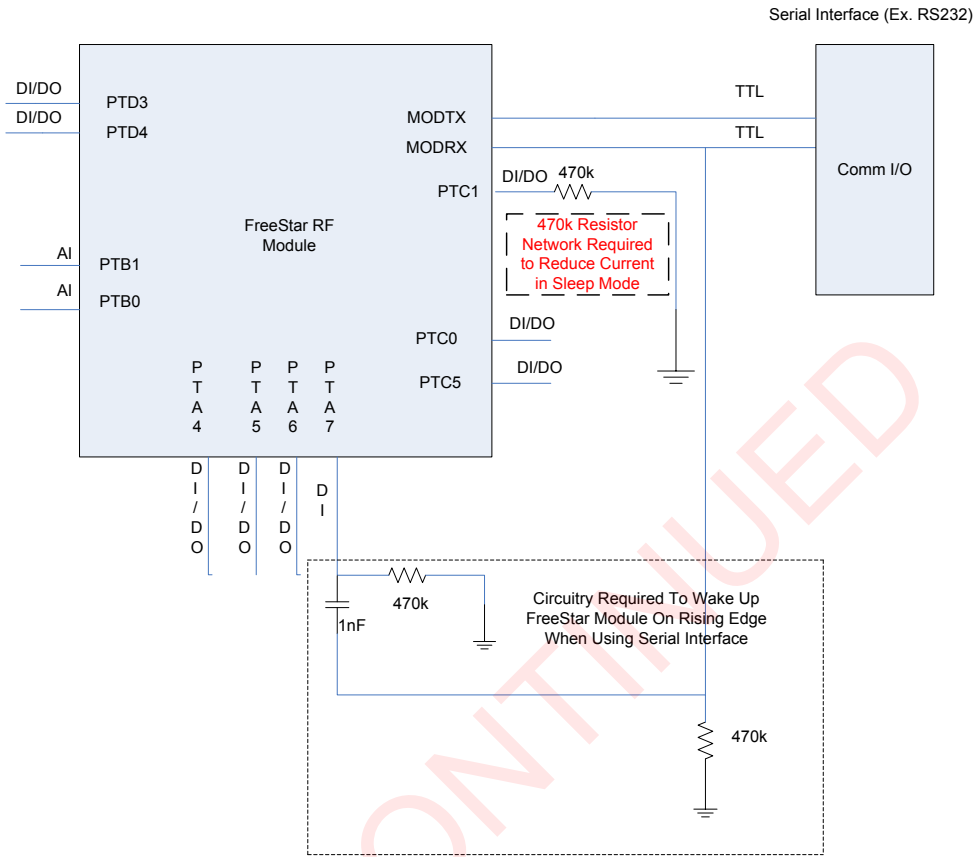

Sample Connection Diagram when Using Host Processor Interface

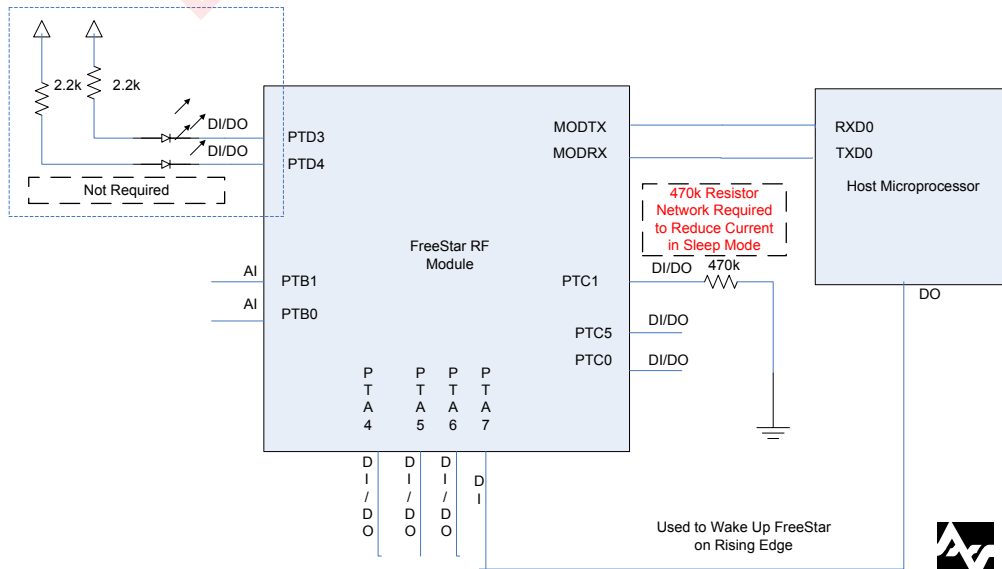

MECHANICAL DRAWINGS

