

**DATA SHEET**  
**SE2442L: 902 MHz–928 MHz High Power RF Front-End Module**

**Applications**

- Smart Meters
- In-home appliances
- Smart thermostats

**Features**

- Integrated PA with 30 dBm output power
- Receive pass through
- Integrated antenna switching
- Single ended 50 Ω Tx & Rx RF interface
- Fast turn-ON / turn-OFF time <1 μsec
- 2.0 V – 4.8 V supply operation
- Sleep mode current <1 μA
- 4 x 4 x 0.9 mm 24 pin QFN
- Pb-free, RoHS compliant and Halogen free

**Product Description**

The SE2442L is a high performance, integrated RF Front End Module designed for high power ISM band applications operating in the 902 – 928 MHz frequency band.

The SE2442L is designed for ease of use and maximum flexibility, with fully matched 50 Ω input and output, and digital controls compatible with 1.6 – 3.6 V CMOS levels.

The RF blocks operate over a wide supply voltage range from 2.0 to 4.8 V allowing the SE2442L to be used in battery powered applications over a wide spectrum of the battery discharge curve.

**Ordering Information**

Part No.	Package	Remark
SE2442L-S	24 pin QFN	Samples
SE2442L-R	24 pin QFN	Tape & Reel
SE2442L-EK1	N/A	Evaluation kit

**Functional Block Diagram**

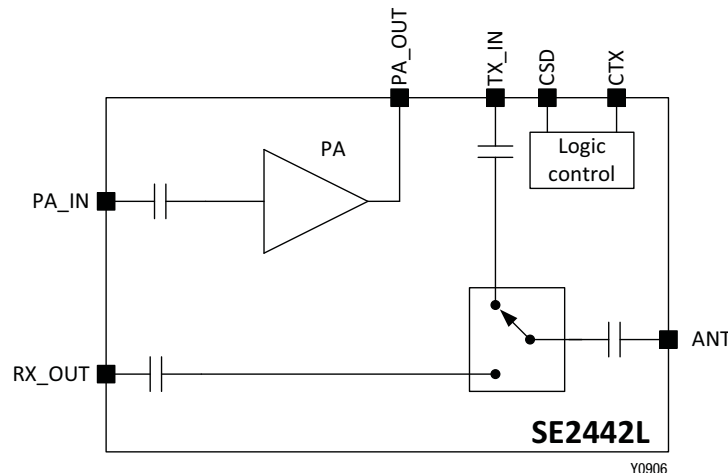

**Figure 1: SE2442L Block Diagram**

**DATA SHEET**  
**SE2442L: 902 MHz–928 MHz High Power RF Front-End Module**

**Pin Out Diagram**

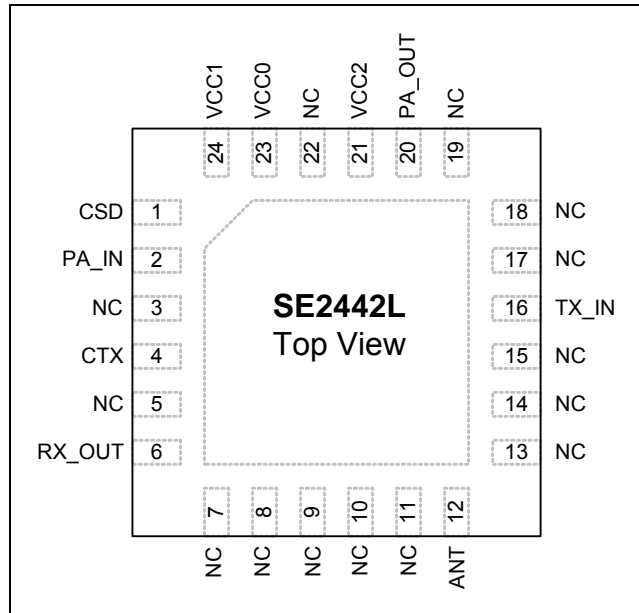

**Figure 2: SE2442L Pinout**

**Pin Out Description**

Pin No.	Name	Description
1	CSD	Shutdown control input
2	PA_IN	PA input
3	NC	Not connected internally to the device
4	CTX	Transmit enable control input
5	NC	Not connected internally to the device
6	RX_OUT	Receive signal to transceiver or SoC
7	NC	Not connected internally to the device
8	NC	Not connected internally to the device
9	NC	Not connected internally to the device
10	NC	Not connected internally to the device
11	NC	Not connected internally to the device
12	ANT	Antenna port
13	NC	Not connected internally to the device
14	NC	Not connected internally to the device
15	NC	Not connected internally to the device

**DATA SHEET**  
**SE2442L: 902 MHz–928 MHz High Power RF Front-End Module**

Pin No.	Name	Description
16	TX_IN	Tx signal to antenna switch (from OMN)
17	NC	Not connected internally to the device
18	NC	Not connected internally to the device
19	NC	Not connected internally to the device
20	PA_OUT	PA output (to OMN)
21	VCC2	Positive power supply, transmit section
22	NC	Not connected internally to the device
23	VCC0	Positive power supply, receive section
24	VCC1	Positive power supply, transmit section
Paddle	GND	Exposed die paddle; electrical and thermal ground; Connect to PCB ground

**Absolute Maximum Ratings**

These are stress ratings only. Exposure to stresses beyond these maximum ratings may cause permanent damage to, or affect the reliability of the device. Avoid operating the device outside the recommended operating conditions defined below.

Symbol	Definition	Note	Min.	Max.	Unit
VCC0	Supply Voltage Receive	1	-0.3	5.5	V
VCC1, VCC2	Supply Voltage Transmit – No RF	1	-0.3	5.5	V
	Control pin voltages		-0.3	VCC0	V
T <sub>OP</sub>	Operating temperature		-40	85	°C
T <sub>STORAGE</sub>	Storage temperature		-40	125	°C
	ESD Voltage all pins (HBM)	1	-	1000	V
Pin_Tx_max	Tx input power at PA_IN port		-	+10	dBm
Pin_Rx_max	Rx input power at ANT port		-	+10	dBm

**Note:** (1) No damage assuming only one parameter is set at limit at a time with all other parameters set at or below the recommended operating conditions.

**Recommended Operating Conditions**

Symbol	Parameter	Min.	Typ.	Max.	Unit
T <sub>A</sub>	Ambient temperature	-40	25	85	°C
VCC	Supply voltage on VCC0, VCC1 and VCC2	2.0	3.6	4.8	V

**DATA SHEET**  
**SE2442L: 902 MHz–928 MHz High Power RF Front-End Module**

**DC Electrical Characteristics**

Conditions:  $V_{CC} = 3.6\text{ V}$ ,  $T_A = 25\text{ }^\circ\text{C}$ , as measured on Skyworks Solutions' SE2442L-EK1 evaluation board (de-embedded to device), unless otherwise noted

Symbol	Parameter	Conditions	Min.	Typ.	Max.	Unit
$I_{CC-Tx30}$	Tx Supply Current	Tx mode $P_{OUT} = 30\text{ dBm}$ CSD = CTX = HIGH, $V_{CC} = 4.8\text{ V}$	-	420	-	mA
$I_{CC-Tx27}$	Tx Supply Current	Tx mode $P_{OUT} = 27\text{ dBm}$ CSD = CTX = HIGH, $V_{CC} = 3.6\text{ V}$	-	280	-	mA
$I_{CQ-Tx}$	Quiescent Current	No RF CSD = CTX = HIGH	-	50	-	mA
$I_{CC-RxBypass}$	Rx Supply Current	Rx bypass mode CSD = HIGH, CTX = 0 V	-	-	280	$\mu\text{A}$
$I_{CC\_OFF}$	Sleep Supply Current	No RF, CTX = CSD = 0 V	-	0.05	1	$\mu\text{A}$

**Logic Characteristics**

Conditions:  $T_A = 25\text{ }^\circ\text{C}$ , as measured on Skyworks Solutions' SE2442L-EK1 evaluation board (de-embedded to device), unless otherwise noted.

Symbol	Parameter	Conditions	Min.	Typ.	Max.	Unit
$V_{IH}$	Logic input high		1.6	-	$V_{CC0}$	V
$V_{IL}$	Logic input low		0	-	0.3	V
$I_{IH}$	Logic input high		-	-	1	$\mu\text{A}$
$I_{IL}$	Logic input low		-	-	1	$\mu\text{A}$

**Logic Controls**

Conditions:  $T_A = 25\text{ }^\circ\text{C}$

Mode	Mode description	Note	CSD	CTX
0	All off (sleep mode)	1, 3	0	0
1	Rx bypass mode	1, 2	1	0
3	Tx mode	1, 2	1	1

- Note:**
- (1) Logic '0' level compliant to  $V_{IL}$  as specified in the "Logic Characteristics" table
  - (2) Logic '1' level compliant to  $V_{IH}$  as specified in the "Logic Characteristics" table
  - (3) All controls must be at logic '0' in order to achieve the specified sleep current

**DATA SHEET**  
**SE2442L: 902 MHz–928 MHz High Power RF Front-End Module**

**AC Electrical Characteristics, Transmit**

Conditions: VCC = 3.6 V, T<sub>A</sub> = 25 °C, as measured on Skyworks Solutions' SE2442L-EK1 evaluation board (de-embedded to device), all unused ports terminated with 50 Ω, unless otherwise noted.

Symbol	Parameter	Condition	Note	Min.	Typ.	Max.	Unit
F <sub>IN</sub>	Frequency Range			902	-	928	MHz
P <sub>out_FEM</sub>	Output power at ANT port	VCC = 4.8 V VCC = 4.0 V VCC = 3.6 V VCC = 3.0 V	1, 4	-	31.5 30.0 29.0 27.5		dBm
PAE	PA Power added efficiency	P <sub>out</sub> = 28 dBm at PA_OUT port, 915 MHz			64		%
S <sub>21</sub>	Small Signal Gain	902 – 928 MHz	1	20	-	-	dB
ΔS <sub>21</sub>	Small Signal Gain Variation	Gain variation across frequency range	1	-	-	1	dBp-p
S <sub>22ANT</sub>	Output Return Loss	Into 50 Ω, ANT port	1	-	-10	-6	dB
HD2	2 <sup>nd</sup> Harmonic	P <sub>OUT</sub> = 27 dBm	1, 2	-	-	-22	dBc
HD3 – HD10	3 <sup>rd</sup> – 10 <sup>th</sup> Harmonics	P <sub>OUT</sub> = 27 dBm	1, 2	-	-	-72	dBc
T <sub>ON</sub>	Turn on time		3	-	-	1	us
T <sub>OFF</sub>	Turn off time		4	-	-	1	us
STAB	Stability	CW, P <sub>IN</sub> = +6 dBm 0.1 GHz – 20 GHz Load VSWR = 6:1		All non-harmonically related outputs less than -45 dBm/MHz			
RU	Ruggedness	CW, P <sub>out</sub> = 27 dBm into 50 Ω, Load VSWR = 10:1		No permanent damage			

- Note:**
- (1) 902 – 928 MHz with specified matching network on the SE2442L-EK1 evaluation board
  - (2) Continuous wave (CW)
  - (3) From 50% of CTX edge to 90% of final RF output power
  - (4) From 50% of CTX edge to 10% of final RF output power

**DATA SHEET**  
**SE2442L: 902 MHz–928 MHz High Power RF Front-End Module**

**AC Electrical Characteristics, Receive**

Conditions: VCC = 3.6 V, T<sub>A</sub> = 25 °C, as measured on Skyworks Solutions' SE2442L-EK1 evaluation board (de-embedded to device), all unused ports terminated with 50 Ω, unless otherwise noted.

Symbol	Parameter	Condition	Note	Min.	Typ.	Max.	Unit
F <sub>IN</sub>	Frequency Range		4	902	-	932	MHz
S <sub>11ANT</sub>	Antenna port return loss	Into 50 Ω, ANT port	1, 4	-	-10	-6	dB
T <sub>ON</sub>	Turn on time		2, 4	-	-	1	us
T <sub>OFF</sub>	Turn off time		3, 4	-	-	1	us
G <sub>bp</sub>	Gain in bypass mode	CTX = logic '0' CSD = logic '1'	4	-	-0.7	-	dB
IP1dB	Input 1-dB compression point in bypass mode	CTX = logic '0' CSD = logic '1'	4	10	-	-	dBm

**Note:** (1) 902 – 932 MHz  
 (2) From 50% of CTX edge  
 (4) From 50% of CTX edge  
 (5) Receive section can operate with VCC0 = 2.8 V and VCC1 = VCC2 = 0 V

**AC Electrical Characteristics, Antenna Function**

Conditions: VCC = 3.6 V, T<sub>A</sub> = 25 °C, as measured on Skyworks Solutions' SE2442L-EK1 evaluation board (de-embedded to device), all unused ports terminated with 50 Ω, unless otherwise noted.

Symbol	Parameter	Note	Min.	Typ.	Max.	Unit
Tx_ANT	Insertion loss from TX_IN to ANT	1	-	0.7	-	dB
Rx_ANT	Insertion loss from ANT to RX_OUT	1	-	0.7	-	dB

**Note:** (1) 902 – 928 MHz

**DATA SHEET**  
**SE2442L: 902 MHz–928 MHz High Power RF Front-End Module**

**Package Drawing**

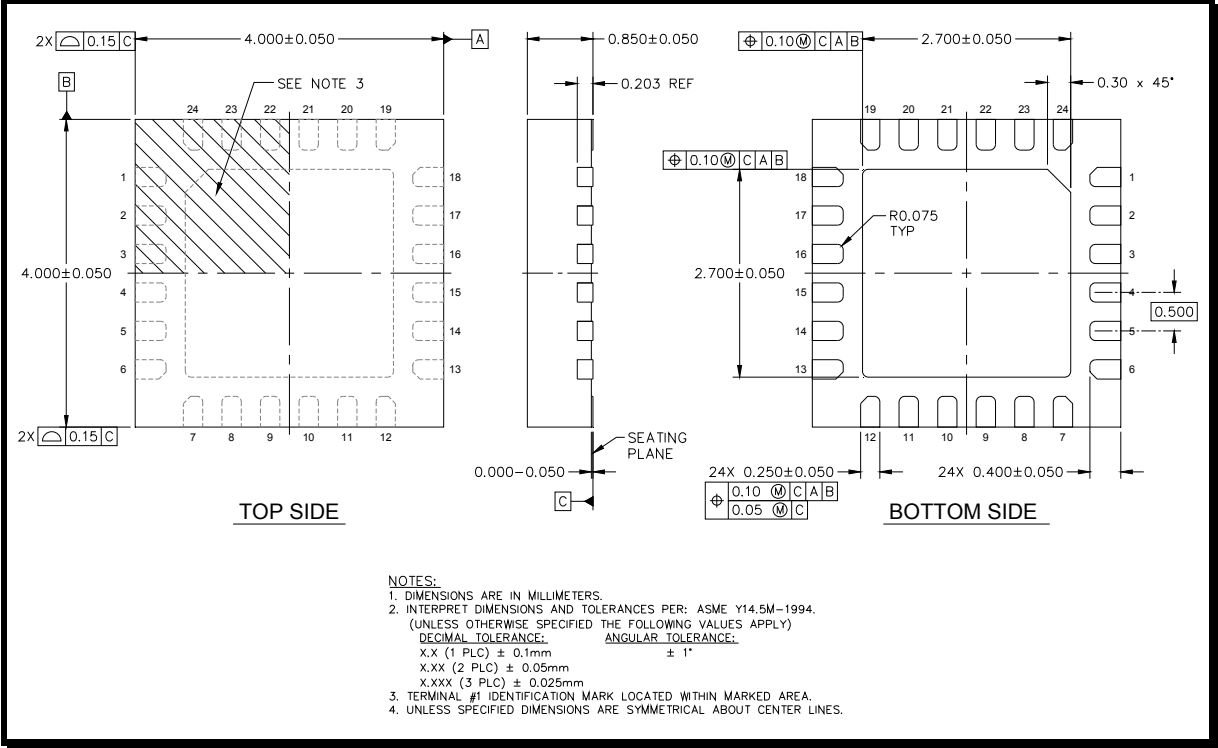
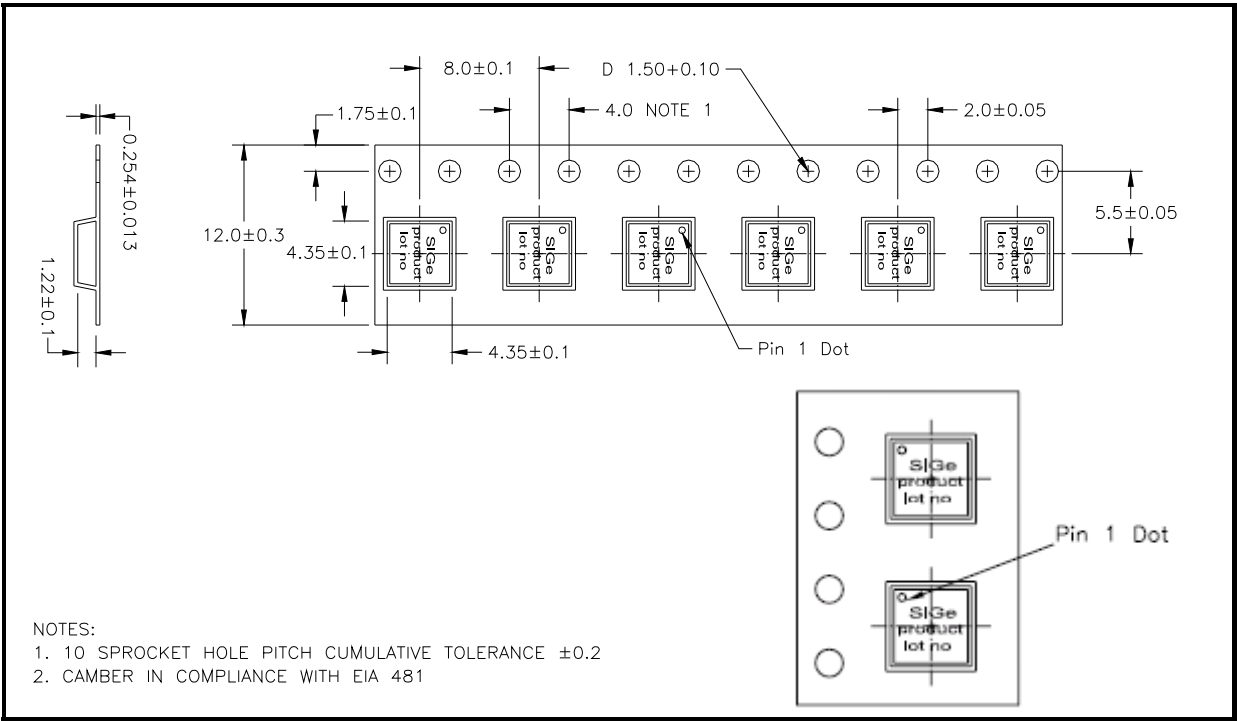

**Figure 3: Package Drawing: Topside**

**DATA SHEET**  
**SE2442L: 902 MHz–928 MHz High Power RF Front-End Module**

**Tape and Reel Information**

Parameter	Value
Devices Per Reel	3000
Reel Diameter	13 inches
Tape Width	12 millimeters



**Figure 4: Detailed Tape and Reel Information (All diminsions in Millimeters)**



**DATA SHEET**  
**SE2442L: 902 MHz–928 MHz High Power RF Front-End Module**

**Recommended Reflow Temperature Profile**

Profile Feature	SnPb Eutectic Assembly	Lead (Pb) Free Assembly
Average Ramp-up Rate ( $T_L$ to $T_P$ )	3°C/s (max)	3°C/s (max)
<b>Preheat</b>		
Temperature Min. ( $T_{smin}$ )	100°C	150°C
Temperature Max. ( $T_{smax}$ )	150°C	200°C
Time (Min. to Max) ( $t_s$ )	60 - 120s	60 - 80s
<b>Ramp Up</b>		
$T_{smax}$ to $t_L$	-	3°C/s (max)
Time 25°C to Peak Temperature	6 mins. (max)	8 mins. (max)
<b>Reflow</b>		
Temperature ( $t_L$ )	183°C	217°C
Time maintained above $t_L$	60 - 150s	60 - 150s
Peak Temperature ( $t_p$ )	240 ±5°C	260 +0/-5°C
Time Within 5°C of Actual Peak Temperature ( $t_p$ )	10 - 30s	20 - 40s
<b>Ramp-Down</b>		
Ramp-Down Rate	6°C/s (max)	6°C/s (max)



Reflow Profile (Reference JEDEC J-STD-020)

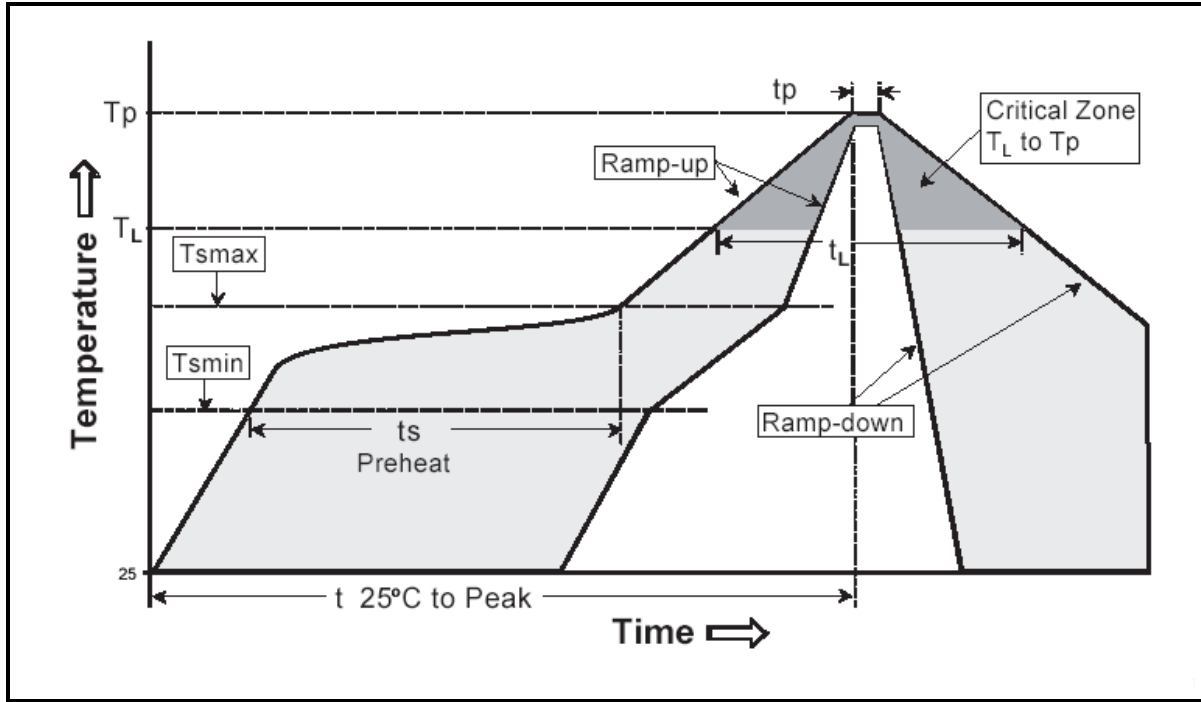
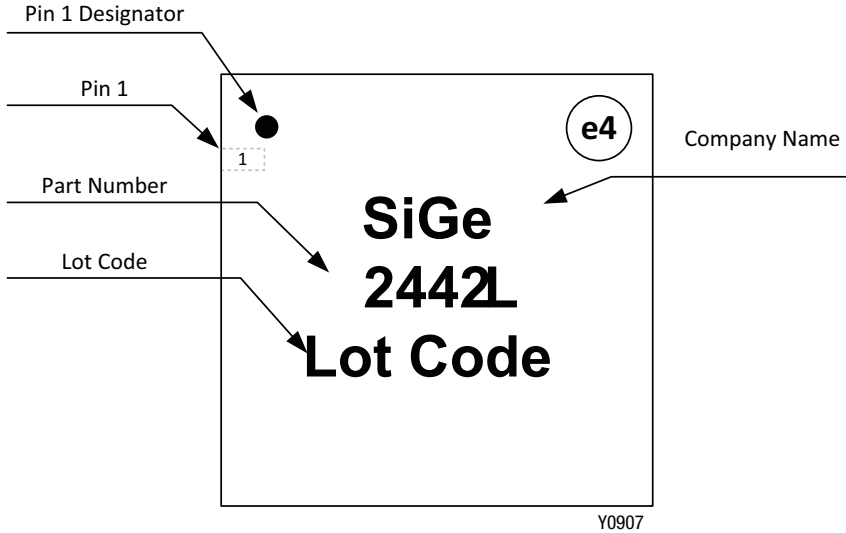

Figure 5: Reflow temperature profile

**DATA SHEET**  
**SE2442L: 902 MHz–928 MHz High Power RF Front-End Module**

**Branding Information**



**Figure 6: SE2442L Branding**

**Document Change History**

Revision	Date	Notes
1.0	October 6, 2010	Initial release
1.1	October 13, 2010	Updated pinout
1.2	December 09, 2010	Included DC, Tx, Rx performance characteristics
1.3	August 08, 2011	Updated parameters according to final product characterization
1.4	April 10, 2012	Updated with Skyworks logo and disclaimer statement

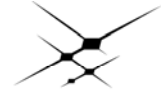

**SKYWORKS®**

## **DATA SHEET**

### **SE2442L: 902 MHz–928 MHz High Power RF Front-End Module**

---

Copyright © 2010-2012, 2014 Skyworks Solutions, Inc. All Rights Reserved.

Information in this document is provided in connection with Skyworks Solutions, Inc. ("Skyworks") products or services. These materials, including the information contained herein, are provided by Skyworks as a service to its customers and may be used for informational purposes only by the customer. Skyworks assumes no responsibility for errors or omissions in these materials or the information contained herein. Skyworks may change its documentation, products, services, specifications or product descriptions at any time, without notice. Skyworks makes no commitment to update the materials or information and shall have no responsibility whatsoever for conflicts, incompatibilities, or other difficulties arising from any future changes.

No license, whether express, implied, by estoppel or otherwise, is granted to any intellectual property rights by this document. Skyworks assumes no liability for any materials, products or information provided hereunder, including the sale, distribution, reproduction or use of Skyworks products, information or materials, except as may be provided in Skyworks Terms and Conditions of Sale.

THE MATERIALS, PRODUCTS AND INFORMATION ARE PROVIDED "AS IS" WITHOUT WARRANTY OF ANY KIND, WHETHER EXPRESS, IMPLIED, STATUTORY, OR OTHERWISE, INCLUDING FITNESS FOR A PARTICULAR PURPOSE OR USE, MERCHANTABILITY, PERFORMANCE, QUALITY OR NON-INFRINGEMENT OF ANY INTELLECTUAL PROPERTY RIGHT; ALL SUCH WARRANTIES ARE HEREBY EXPRESSLY DISCLAIMED. SKYWORKS DOES NOT WARRANT THE ACCURACY OR COMPLETENESS OF THE INFORMATION, TEXT, GRAPHICS OR OTHER ITEMS CONTAINED WITHIN THESE MATERIALS. SKYWORKS SHALL NOT BE LIABLE FOR ANY DAMAGES, INCLUDING BUT NOT LIMITED TO ANY SPECIAL, INDIRECT, INCIDENTAL, STATUTORY, OR CONSEQUENTIAL DAMAGES, INCLUDING WITHOUT LIMITATION, LOST REVENUES OR LOST PROFITS THAT MAY RESULT FROM THE USE OF THE MATERIALS OR INFORMATION, WHETHER OR NOT THE RECIPIENT OF MATERIALS HAS BEEN ADVISED OF THE POSSIBILITY OF SUCH DAMAGE.

Skyworks products are not intended for use in medical, lifesaving or life-sustaining applications, or other equipment in which the failure of the Skyworks products could lead to personal injury, death, physical or environmental damage. Skyworks customers using or selling Skyworks products for use in such applications do so at their own risk and agree to fully indemnify Skyworks for any damages resulting from such improper use or sale.

Customers are responsible for their products and applications using Skyworks products, which may deviate from published specifications as a result of design defects, errors, or operation of products outside of published parameters or design specifications. Customers should include design and operating safeguards to minimize these and other risks. Skyworks assumes no liability for applications assistance, customer product design, or damage to any equipment resulting from the use of Skyworks products outside of stated published specifications or parameters.

Skyworks, the Skyworks symbol, and "Breakthrough Simplicity" are trademarks or registered trademarks of Skyworks Solutions, Inc., in the United States and other countries. Third-party brands and names are for identification purposes only, and are the property of their respective owners. Additional information, including relevant terms and conditions, posted at [www.skyworksinc.com](http://www.skyworksinc.com), are incorporated by reference.